

Spectrum TEZP-405-30-V1

2MP 40x Explosion Proof PTZ Network Camera

Key Features

- 1/2.8" Sony CMOS Sensor
- NETWORK
- 40x Optical Zoom (4.25mm to 170.0mm) and 32x Digital Zoom
- Digital Noise Reduction
- Defog Function
- 255 Presets, 8 Tours, 4 Patterns
- 360° Endless Pan Rotation
- IR Night Distance up to 200m
- 316L SS Construction
- IP67
- Triple Streams
- H.265, H.264, MJPEG
- Built-in Web Server
- ONVIF Compatibility
- 5 YEAR WARRANTY
- ONVIF | G | M | S | T

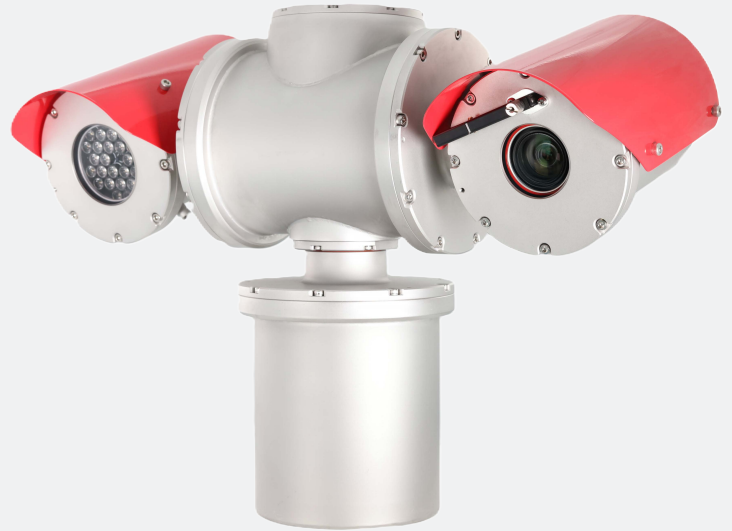

Description

Spectrum TEZP-405-30-V1 Explosion-Proof Network camera delivers a maximum Frame Rate of 60fps at 1080p and 40x Optical Zoom. Enclosed in a 316L Stainless Steel Explosion-Proof housing, it's certified (ATEX & IECEx Approved) for use in potentially combustible environments.

Optional Accessories



Wall
Bracket
T-WM



Corner
Bracket
T-CM



Pole
Mount
T-PM



Pedestal
Bracket
T-PB

Specifications

Spectrum TEZP-405-30-V1

Camera

Image Sensor	1/2.8" Sony CMOS Sensor
Lens	Type: 40x Day & Night Zoom Lens Zoom Ratio: Optical 40x, Digital 32x Focal Length: F = 4.25mm ~ 170.0mm Aperture Ratio: F1.6 (Wide) ~ F4.95 (Tele) Angle of View: Wide = D 73.8° / H 63.35° / V 39.98° Tele = D 2.16° / H 1.90° / V 1.11°
Day and Night	Auto / Day / Night
Minimum illumination	Color: 0.01 lux / DSS 0.001 lux B/W: 0.002 lux / DSS 0.0002 lux
Shutter speed	1/30 (25) ~ 1/30,000 sec
Digital Slow Shutter	Off / x2 / x4 / x8 / x16 / x32 / x64 (60fps or 50fps Mode Only)
Gain Control	0 ~ 10 Steps
Pixels	Total: 1945 (H) x 1109 (V) = 2.16M Active: 1937 (H) x 1097 (V) = 2.12M
S/N Ratio	More than 50dB (AGC Off)
Privacy Mask	On / Off (8 Positions)
Image Stabilization	On / Off
WDR / BLC	Off / WDR / BLC / HLC / ACE
DNR	Auto / Off / Low / Middle / High
Defog	On / Off
White Balance	Auto / One Push / Manual / Indoor / Outdoor Auto-Ext
E.Zoom	On / Off
Digital I/O	1 Alarm / 1 Relay Out

Pan / Tilt

Pan	360° Continuous, 0.05° ~ 50° / Sec
Pan Speed	0.5° ~ 80° / Sec
Tilt	-90° ~ +90°, 0.1° ~ 50° / Sec
Tilt Speed	0.1° ~ 60° / Sec
Preset	255 Points, less than 0.25° accuracy

Video

Video Compression	H.265, H.264, MJPEG
Video Format	1080p@60/50fps, 1080p@30/25fps, 720p@60/50fps, 720p@30/25fps
Video Output	Network
Resolution	1920x1080, 1280x720, 1024x576, 640x360, D1, 4CIF, VGA, CIF, QVGA
Frame Rate (Max)	Up to 60fps@1920x1080
Video Streaming	Supports up to Triple Streams (H.265, H.264, MJPEG)

Network

Security	Multi-Level Security
Ethernet	RJ45 10/100 Base-T
Supported Protocols	HTTP, RTP/RTSP (Uni/Multicast), TCP/IP (V4/V6), UDP, FTP, Telnet, HTTPS, RARP, PPPoE, SNMP, PAP, CHAP, DHCP, NTP, SMTP, Client, uPnP

General

Casing	Stainless Steel 316L
Weight	79.4 lbs (36 kg)
Power Source	100 - 240VAC: Max 120W
Operating Conditions	-40°C to 60°C (-40°F to 140°F) Humidity 0-95% RH (condensing)
IP Rating	IP67
Warranty	5-year warranty
Approvals	ATEX & IECEx
Explosion-Proof Certifications	Ex II 2 GD Ex db IIC T6 Gb Ex tb IIIC T80°C Db
Dimensions	24.1(W) x 17.2(H) x 9.3(D) inches 611(W) x 438(H) x 235(D) mm

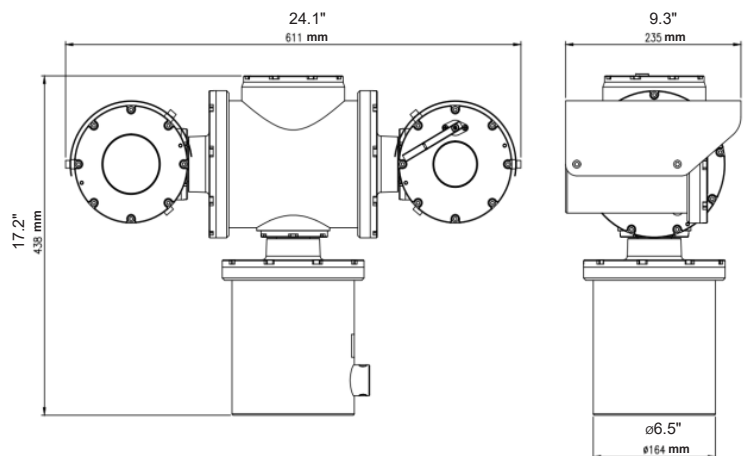

Notes:

- 1 - Non-compliant to GB 28181, GB/T 28181 - 2011 standards.
- 2 - No option to activate or deactivate GB/T 28181 standards in the camera web page / settings.

Approvals



SPECTRUM
CAMERA SOLUTIONS 

CE 2809

MANUFACTURER: Spectrum Camera Solutions, LLC 8935 ALMEDA GENOA RD. HOUSTON, TEXAS 77075 USA
SPECIALIZING IN EXPLOSION PROOF TECHNOLOGY

MODEL: TEZP-405-30-V1 **SERIAL:** XXXXXXXXXXXXX
INPUT: 100-240Vac, 1.7A, 50/60Hz, Max 120W **YEAR:** 20XX

 II 2 G Ex db IIC T6 Gb Ta = -40°C to +60°C, IP67
II 2 D Ex tb IIIC T80°C Db Ta = -40°C to +60°C, IP67

IECEX KTL 24.0018X

 **WARNING: DO NOT OPEN WHEN ENERGIZED OR WHEN AN EXPLOSIVE ATMOSPHERE MAY BE PRESENT**
ENTRY SIZE: NPT 3/4"-14 OR M25xP1.5

www.spectrumcamera.com